

# TE



Desbrozadora fija polivalente para tractores de 30 a 60 Hp con anchos de 145 a 220 cm ideal tanto para el viñedo o plantación de árboles frutales como para el campo abierto.

Posición de trabajo doble: centrada o descentrada (320 mm)



## DATOS TÉCNICOS

### Velocidad del reductor:











**540 rpm**

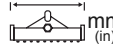

2082 rpm

### Modelos y Características:

	 HP	 mm (in)	 mm (in)	 mm (in)	 kg (lbs)	 nr.	 nr.	 nr.	 cat.
<b>TE 145</b>	30 ▶ 60	1450 (57")	1580 (63")	300 (12")	320 (705)	36	18	3	1
<b>TE 160</b>	30 ▶ 60	1600 (63")	1780 (70")	300 (12")	350 (772)	40	20	3	1
<b>TE 180</b>	30 ▶ 60	1800 (80")	1980 (77")	300 (12")	380 (838)	44	22	3	1
<b>TE 200</b>	30 ▶ 60	2000 (81")	2180 (87")	300 (12")	420 (926)	52	26	4	1
<b>TE 220</b>	30 ▶ 60	2200 (87")	2380 (94")	300 (12")	440 (970)	56	28	4	1

# VERSIÓN MOVIBLE

Desbrozadora desplazable media para tractores de 30 a 60 Hp con anchos de 145 a 220 cm ideal tanto para el viñedo o árboles frutales como para el campo abierto.

Posición de trabajo desplazable

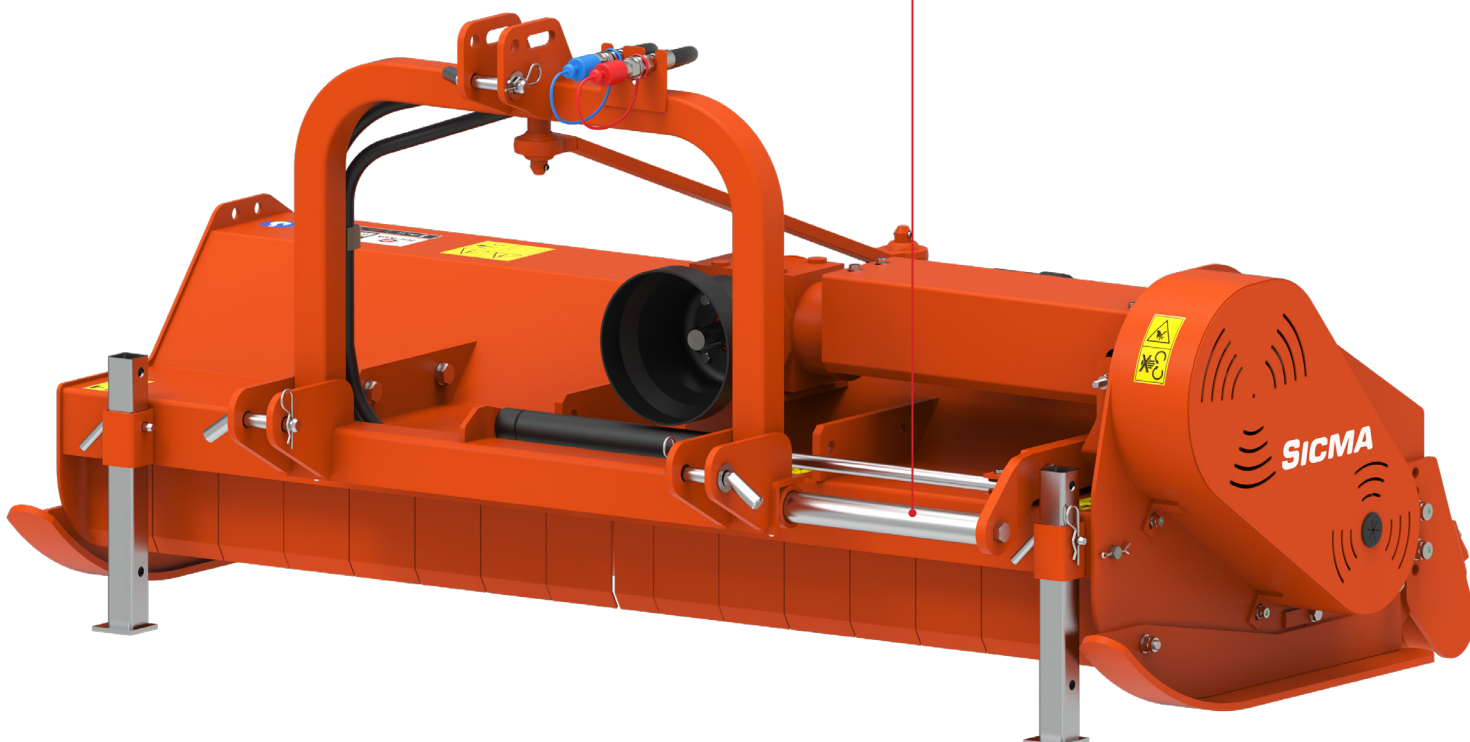





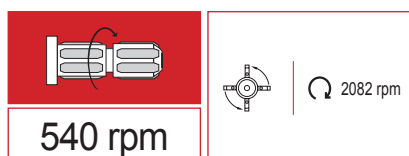



## DATOS TÉCNICOS

Velocidad del reductor:



Modelos y Características:

	 HP	 mm (in)	 mm (in)	 mm (in)	 kg (lbs)	 nr.	 nr.	 nr.	 cat.
<b>TE 145</b>	30 ▶ 60	1450 (57")	1580 (63")	300 (12")	340 (750)	36	18	3	1
<b>TE 160</b>	30 ▶ 60	1600 (63")	1780 (70")	300 (12")	370 (816)	40	20	3	1
<b>TE 180</b>	30 ▶ 60	1800 (80")	1980 (77")	300 (12")	400 (882)	44	22	3	1
<b>TE 200</b>	30 ▶ 60	2000 (81")	2180 (87")	300 (12")	440 (970)	52	26	4	1
<b>TE 220</b>	30 ▶ 60	2200 (87")	2380 (94")	300 (12")	460 (1014)	56	28	4	1



EUROCARDAN  
ENERGY ON THE MOVE



Zapfwelle (Eurocardan)  
Größe 5



POLYESTER  
POWDER COATING

Multiplicador de fabricación SICMA, equipado de cojinetes de rodillos cónicos, rueda libre incorporada, tapones de carga y descarga de aceite y tapón de nivel con mirilla

Grapas traseras en la versión con martillos

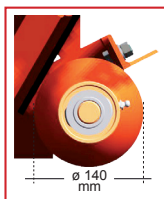
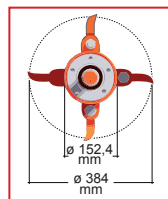

Cojinetes del soporte del rodillo estabilizador trasero blindados y protegidos contra el contacto con los agentes externos (tierra, hierba, residuos de poda)

Sistema de contraCuchillas en el interior de la cámara de corte

Paletas de protección de lanzamiento de objetos

Transmisión con correas trapezoidales y sistema tensor de correa manual

Soportes de rotor con cojinetes de alta fiabilidad equipados con sellos lubricantes NILOS

Ensambladores de poleas autocentrantes de alta resistencia

Eje helicoidal

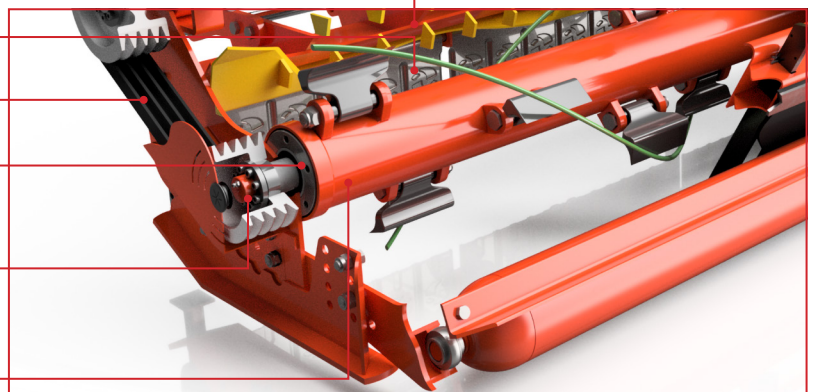

# VERSIONES DE ROTORES Y HERRAMIENTAS

El funcionamiento perfecto del desbrozador depende en gran medida del rotor, un componente esencial de una máquina de alto rendimiento, ya que su rotación permite a las herramientas triturar hierba o restos

de poda. Las características más relevantes del rotor (dejando de lado el ancho como volumen y el peso) son, sin duda, el grosor del acero utilizado y el diámetro.

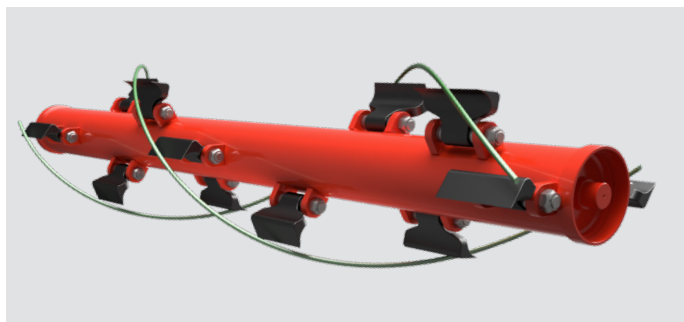

## ROTOR MAZAS LISAS HELICOIDAL

Para césped, arbustos, mantenimiento de jardines; sarmientos, poda de tamaño medio; poda de residuos leñosos de viñedos y olivares.

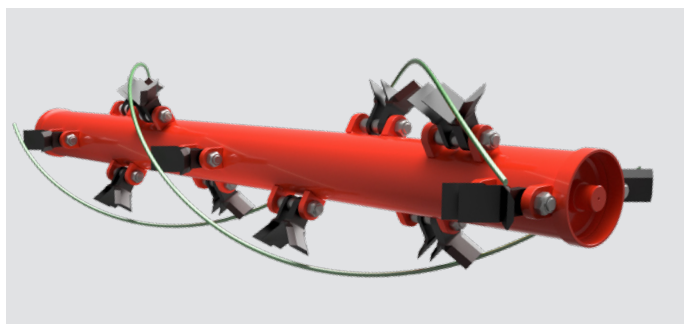
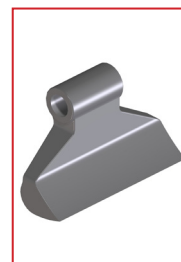

## ROTOR CUCHILLAS HELICOIDAL

Para césped, arbustos, mantenimiento de jardines; sarmientos, paja, tallos.

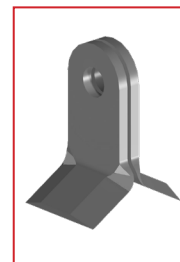

# ACCESORIOS



## Kit ruedas en goma directrices en lugar del rodillo

Ideal para suelos pedregosos y no compacta el terreno como un rodillo.

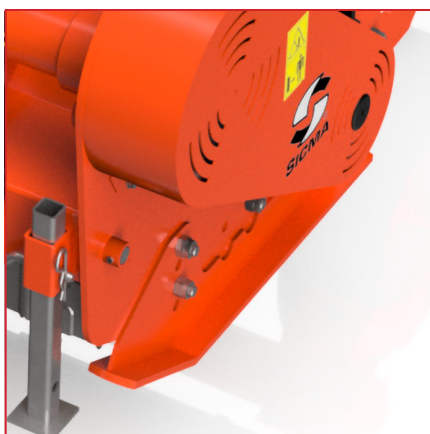

## Correderas laterales

Permiten el ajuste de la altura de trabajo.



## Gato hidráulico para desplazamiento

Permite mover lateralmente la cortadora con un gato sin bajar del tractor



®

**SICMA**

*La experiencia que cultiva  
el futuro de tu tierra*

SICMA S.p.a. es una empresa italiana líder en el sector de la maquinaria agrícola profesional. Diseñamos y fabricamos soluciones de vanguardia para ti, agricultor del mañana. Innovación y pasión a tu servicio.



MIGLIANICO | ABRUZZO | ITALY

**Sicma SpA**

Contrada Cerreto, 39  
66010 Miglianico (CH)  
Tel. +39 0871 95841

[info@sicma.it](mailto:info@sicma.it) - [www.sicma.it](http://www.sicma.it)

